

SYSTEEM TOP 100

Productbeschrijving

Het TOP-systeem dekt de belastingsklassen A15 tot en met C250 af met een verzinkt sleuvenrooster, mazenrooster of een gietijzeren rooster. Alle gootelementen worden compleet gemonteerd en met de bijbehorende afdekroosters geleverd.

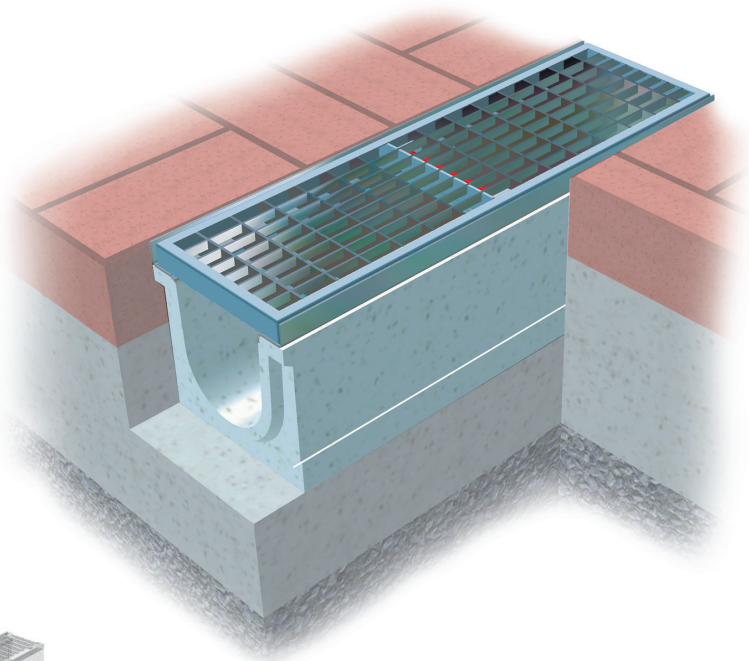

Afb.: Inbouw voorbeeld

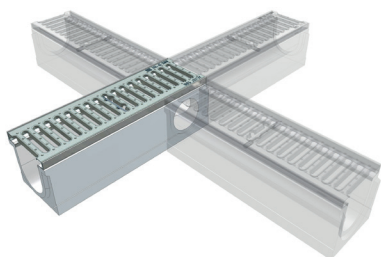

Afb.: Speciaal element als kruisverbinding

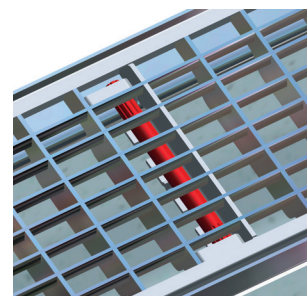

Afb.: Vergrendeling TOP

- afdekroosters met verzinkt sleuvenrooster, verzinkt mazenrooster of gietijzeren rooster
- schroefloze, gepatenteerde roosterbevestiging
- verzinkt stalen randbescherming
- gootelement uit vezel versterkt beton C35/45
- nauwkeurig aansluitende verbindingen
- vaste verankering d.m.v. lengteribben verhindert "omhoog drijven"
- voorgevormde verticale afvoer in de gootbodern DN 100/150
- voegverbinding met veiligheidsvoeg
- EN 1433, DIN 19580, type M

Toepassingsgebieden

- fiets- en voetgangerspaden
- schoolpleinen
- autoparkeerplaatsen

SYSTEEM TOP 100

Modulesysteem

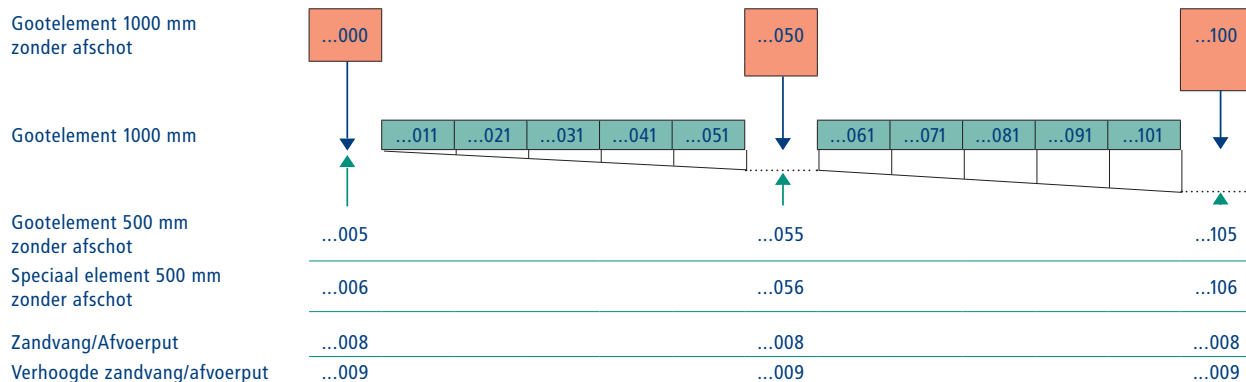

Referenties TOP

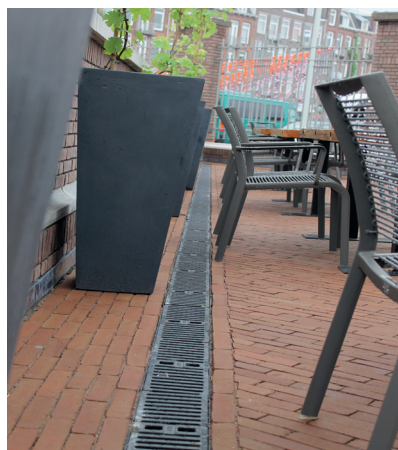

Project: Hotel de Hallen, Amsterdam

SYSTEEM TOP 100

A 15 - C 250 met verzinkt stalen frame en sleuvenrooster



Leveringsprogramma

Artikel	Artikel-Nr. A 15	Gewicht kg	Artikel-Nr. C 250	Gewicht kg	Lengte mm	Inbouwhoogte (mm)		Stuks per pallet	
						Inlaat	Uitlaat		
	13563210...		13563430...						
Goothelement	160	...000	...000	35,9	38,2	1000	160	160	24
		...005	...005	18,0	20,0	500	160	160	48
Speciaal element	160	...006	...006	17,0	19,5	500	160	160	48
		...050	...050	33,9	42,2	1000	185	185	24
Goothelement	185	...055	...055	20,0	21,0	500	185	185	48
Speciaal element		185	...056	...056	19,0	20,5	500	185	185
Goothelement	210		...100	...100	43,7	46,0	1000	210	210
Speciaal element		210	...105	...105	22,0	22,5	500	210	210
	210		...106	...106	21,0	21,0	500	210	210
Zandvang/ Afvoerput		500	...008	...008	45,5	47,0	500	500	500
Goothelement met Afschot 0,5 %	160 - 185	...011	...011	36,3	38,6	1000	160	165	24
		...021	...021	37,1	39,4	1000	165	170	24
		...031	...031	37,9	40,2	1000	170	175	24
		...041	...041	38,7	41,0	1000	175	180	24
		...051	...051	39,5	41,8	1000	180	185	24
Goothelement met Afschot 0,5 %	185 - 210	...061	...061	40,3	42,6	1000	185	190	24
		...071	...071	41,0	43,3	1000	190	195	24
		...081	...081	41,8	44,1	1000	195	200	24
		...091	...091	42,5	44,8	1000	200	205	24
		...101	...101	43,3	45,6	1000	205	210	24

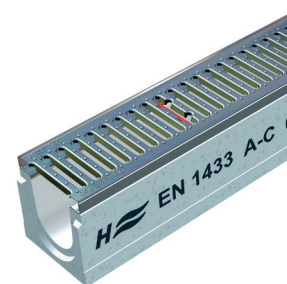

met sleuvenrooster

Toebehoren voor TOP 100

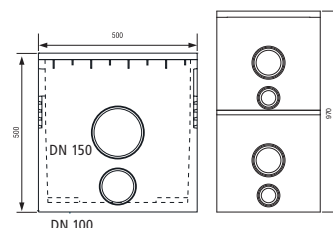

Inlaat oppervlakte 359 cm²/m

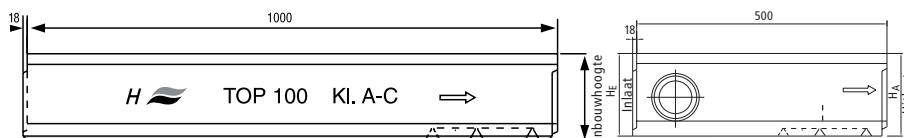
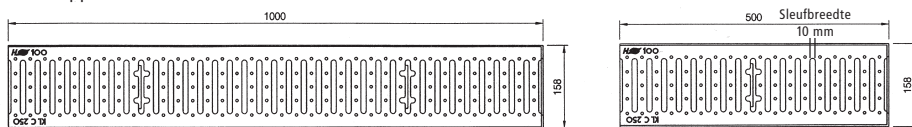

Goothelement 1000 mm bouw lengte

DN 100
DN 150 oval

Speciaal element
500 mm

DN 100
DN 150 oval

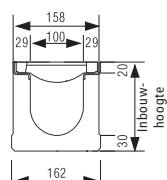

Zandvang/Afvoerput Verhoogde
incl. verzinkte emmer zandvang/afvoerput

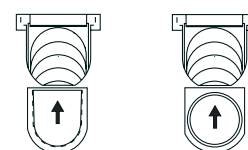

Begin/eindplaat

gesloten met Aansluitpie DN 100

Art.Nr.: 1357001110 Art.Nr.: 1357001120



Stankslot DN 100
Art.Nr.: 1357003100

Gietijzeren begin/eindplaat
Art.Nr.: 1357001111 voor BH 160
Art.Nr.: 1357001112 voor BH 185

SYSTEEM TOP 100

A 15 - C 250 met verzinkt stalen frame en sleuvenrooster verlaagde goot



Leveringsprogramma

		Artikel-Nr. A 15		Artikel-Nr. C 250		Lengte mm	Inbouwhoogte (mm)		Stuks per pallet
			Gewicht kg		Gewicht kg		Inlaat	Uitlaat	
		1356321000...		1356343000...					
Gotoelement	80	...00080	20,0	...00080	22,2	1000	80	80	24
Afvoerelement * gezaagd		...70080	20,0	...70080	22,2	1000	80	80	24
		...50080	10,0	...50080	11,1	500	80	80	48
Gotoelement	100	...00100	24,9	...00100	27,1	1000	100	100	24
Afvoerelement * gezaagd		...70100	24,9	...70100	27,1	1000	100	100	24
		...50100	12,5	...50100	13,5	500	100	100	48
Gotoelement	120	...00120	26,6	...00120	28,8	1000	120	120	24
Afvoerelement * gezaagd		...70120	26,6	...70120	28,8	1000	120	120	24
		...50120	13,3	...50120	14,4	500	120	120	48



met sleuvenrooster

* met verticale afvoer DN 100

Inlaat oppervlakte 359 cm²/m

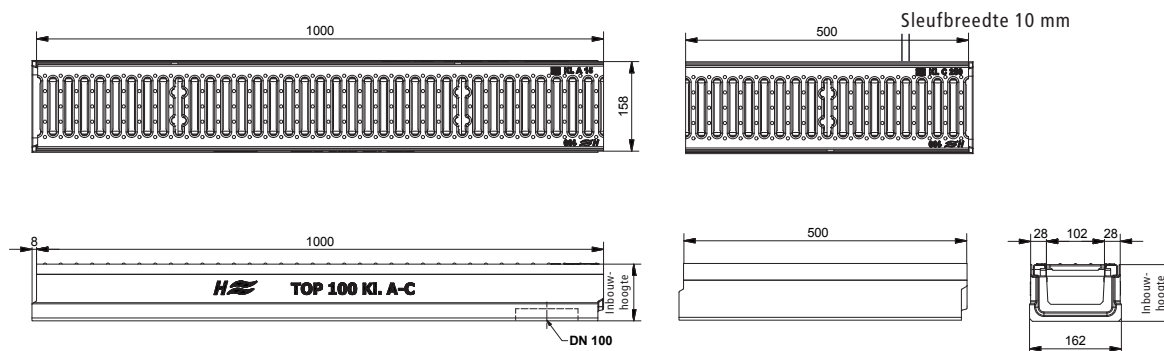

Toebehoren voor TOP 100

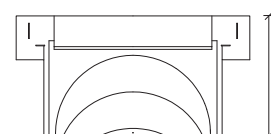

Begin/eindplaat

Art.Nr.:1357001110080 Inbouwhoogte 80
 Art.Nr.:1357001110100 Inbouwhoogte 100
 Art.Nr.:1357001110120 Inbouwhoogte 120

SYSTEEM TOP 100

A 15 - C 250 met verzinkt stalen frame en sleuvenrooster verlaagde goot



Leveringsprogramma

		Artikel-Nr. A 15		Artikel-Nr. C 250		Lengte mm	Inbouwhoogte (mm)		Stuks per pallet
			Gewicht kg		Gewicht kg		Inlaat	Uitlaat	
		1356321000...		1356343000...					
Gotoelement	80	...00080	20,0	...00080	22,2	1000	80	80	24
Afvoerelement * gezaagd		...70080	20,0	...70080	22,2	1000	80	80	24
		...50080	10,0	...50080	11,1	500	80	80	48
Gotoelement	100	...00100	24,9	...00100	27,1	1000	100	100	24
Afvoerelement * gezaagd		...70100	24,9	...70100	27,1	1000	100	100	24
		...50100	12,5	...50100	13,5	500	100	100	48
Gotoelement	120	...00120	26,6	...00120	28,8	1000	120	120	24
Afvoerelement * gezaagd		...70120	26,6	...70120	28,8	1000	120	120	24
		...50120	13,3	...50120	14,4	500	120	120	48



met sleuvenrooster

* met verticale afvoer DN 100

Inlaat oppervlakte 359 cm²/m

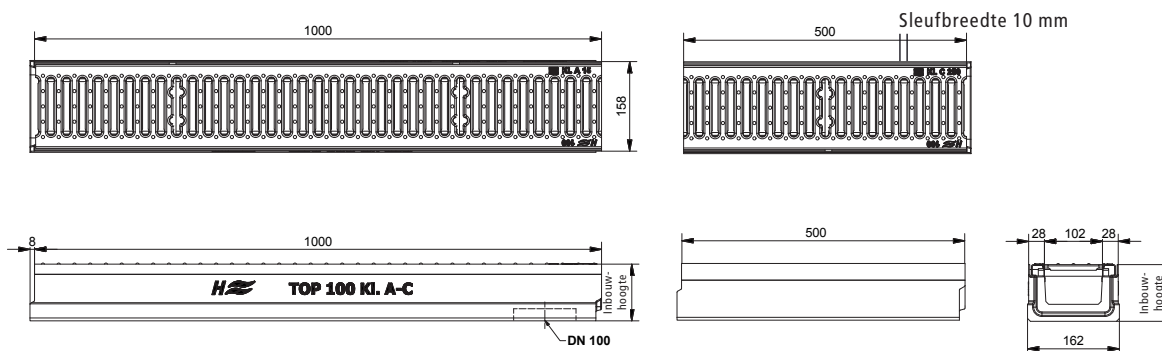

Toebehoren voor TOP 100

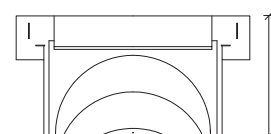

Begin/eindplaat

Art.Nr.:1357001110080 Inbouwhoogte 80
 Art.Nr.:1357001110100 Inbouwhoogte 100
 Art.Nr.:1357001110120 Inbouwhoogte 120

SYSTEEM TOP 100

C 250 met verzinkt stalen frame en mazenrooster 30/10



Leveringsprogramma

Artikel	Artikel-Nr. C 250	Gewicht kg	Lengte mm	Inbouwhoogte (mm) Inlaat	Uitlaat	Stuks per pallet	
13563330...							
Gootelement	160	...000	38,1	1000	160	24	
		...005	19,9	500	160	160	48
Speciaal element	160	...006	18,9	500	160	160	48
		...050	42,1	1000	185	185	24
Gootelement	185	...055	20,9	500	185	185	48
		...056	19,9	500	185	185	48
Gootelement	210	...100	45,9	1000	210	210	24
		...105	22,9	500	210	210	48
Speciaal element	210	...106	21,9	500	210	210	48
		...008	44,4	500	500	500	10
Zandvang/ Afvoerput	500	...008	44,4	500	500	10	
Gootelement met Afschot 0,5 %	160 - 185	...011	38,5	1000	160	165	24
		...021	39,3	1000	165	170	24
		...031	40,1	1000	170	175	24
		...041	40,9	1000	175	180	24
		...051	41,7	1000	180	185	24
Gootelement met Afschot 0,5 %	185 - 210	...061	42,5	1000	185	190	24
		...071	43,2	1000	190	195	24
		...081	44,0	1000	195	200	24
		...091	44,7	1000	200	205	24
		...101	45,5	1000	205	210	24

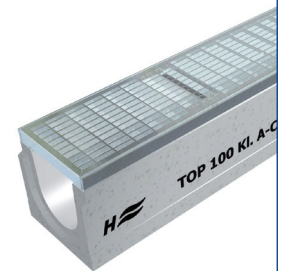

met mazenrooster 30/10

Toebehoren voor TOP 100

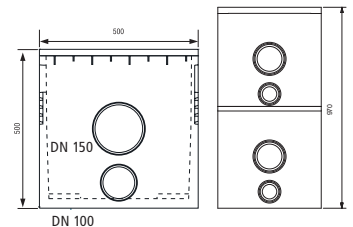

Zandvang/Afvoerput Verhoogde
incl. verzinkte emmer zandvang/afvoerput

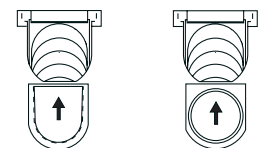

Begin/eindplaat

gesloten met Aansluitspie DN 100
Art.Nr.: 1357001110 Art.Nr.: 1357001120



Stankslot DN 100
Art.Nr.: 1357003100

Gietijzeren begin/eindplaat,
Art.Nr.: 1357001111 voor BH 160
Art.Nr.: 1357001112 voor BH 185

Inlaat oppervlakte 900 cm²/m, afdekkingen 30/10, gootelement met 2 afde kroosters

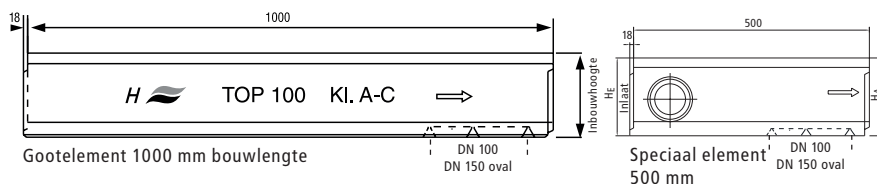

Gootelement 1000 mm bouwlengte

Speciaal element
500 mm

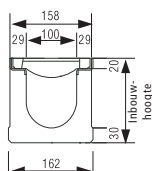

SYSTEEM TOP 100

C 250 met verzinkt stalen frame en mazenrooster 30/10 verlaagde goot



Leveringsprogramma

Artikel	Artikel-Nr.	Gewicht kg	Lengte mm	Inbouwhoogte (mm) Inlaat Uitlaat	Stuks per pallet
1356333000...					
Gotoelement Afvoerelement * <i>gezaagd</i>	80	...00080	22,3	1000 80 80	24
		...70080	21,8	1000 80 80	24
		...50080	11,2	500 80 80	48
Gotoelement Afvoerelement * <i>gezaagd</i>	100	...00100	27,1	1000 100 100	24
		...70100	26,6	1000 100 100	24
		...50100	13,6	500 100 100	48
Gotoelement Afvoerelement * <i>gezaagd</i>	120	...00120	28,9	1000 120 120	24
		...70120	28,4	1000 120 120	24
		...50120	14,5	500 120 120	48



met mazenrooster 30/10

* met verticale afvoer DN 100

Inlaat oppervlakte 900 cm²/m, afdekkingen 30/10, gotoelement met 2 afdekroosters

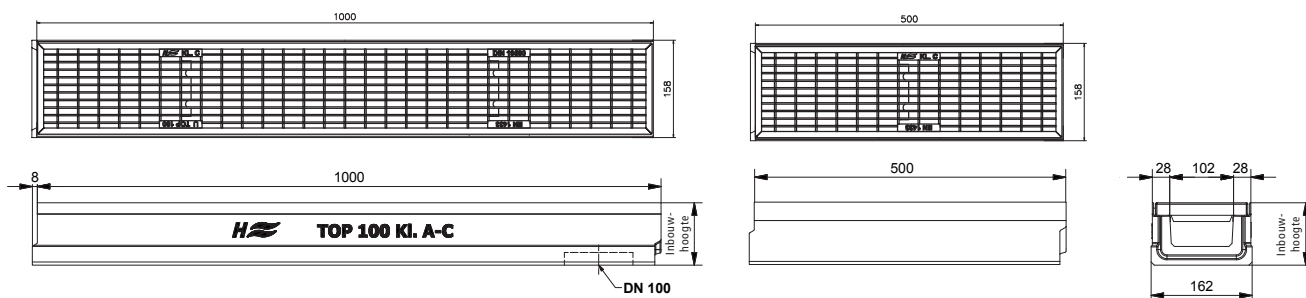

Toebehoren voor TOP 100

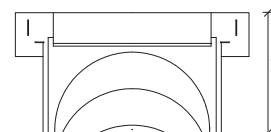

Begin/eindplaat

Art.Nr.:1357001110080 Inbouwhoogte 80
 Art.Nr.:1357001110100 Inbouwhoogte 100
 Art.Nr.:1357001110120 Inbouwhoogte 120

SYSTEEM TOP 100

C 250 met verzinkt stalen frame en gietijzeren rooster



Leveringsprogramma

Artikel	Artikel-Nr. A 15 - C 250	Gewicht kg	Lengte mm	Inbouwhoogte (mm)		Stuks per pallet	
				Inlaat	Uitlaat		
13563130...							
Gooitelement	160	...000	42,5	1000	160	160	24
Speciaal element	160	...005	22,0	500	160	160	48
		...006	21,5	500	160	160	48
Gooitelement	185	...050	46,6	1000	185	185	24
Speciaal element	185	...055	23,5	500	185	185	48
		...056	23,0	500	185	185	48
Gooitelement	210	...100	50,4	1000	210	210	24
Speciaal element	210	...105	24,5	500	210	210	48
		...106	24,0	500	210	210	48
Zandvang/Afvoerput	500	...008	48,0	500	500	500	10
Verhoogde zandvang/ afvoerput	500	...009	90,0	500	970	970	5
Gooitelement met Afschot	160 - 185	...011	42,9	1000	160	165	24
		...021	43,7	1000	165	170	24
		...031	44,5	1000	170	175	24
		...041	45,3	1000	175	180	24
		...051	46,1	1000	180	185	24
Gooitelement met Afschot	185 - 210	...061	47,0	1000	185	190	24
		...071	47,7	1000	190	195	24
		...081	48,5	1000	195	200	24
		...091	49,2	1000	200	205	24
		...101	50,0	1000	205	210	24



met gietijzeren rooster

Toebehoren voor TOP 100

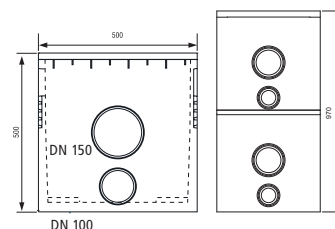

Zandvang/Afvoerput Verhoogde
incl. verzinkte emmer zandvang/afvoerput

Inlaat oppervlakte 564 cm²/m, gooitelement met 2 afdekkroesters, afdekkingen - gietijzer

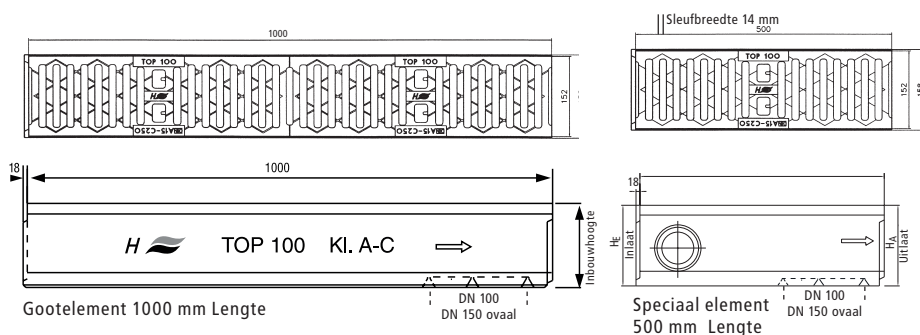

Gooitelement 1000 mm Lengte

Speciaal element
500 mm Lengte

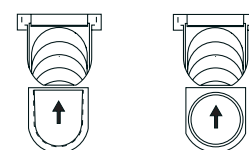
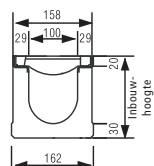

Begin/eindplaat

gesloten Art.Nr.: 1357001110 met Aansluitspie DN 100 Art.Nr.: 1357001120



Stankslot DN 100
Art.Nr.: 1357003100

Gietijzeren begin/eindplaat,
Art.Nr.: 135001111 voor BH 160
Art.Nr.: 1357001112 voor BH 185

SYSTEEM TOP 100

C 250 met verzinkt stalen frame en gietijzeren rooster/verlaagde goot



Leveringsprogramma

Artikel	Artikel-Nr.	Gewicht kg	Lengte mm	Inbouwhoogte (mm)		Stuks per pallet	
				Inlaat	Uitlaat		
1356313000...							
Gotoelement Afvoerelement * <i>gezaagd</i>	80	...00080	25,5	1000	80	80	24
		...70080	25,0	1000	80	80	24
		...50080	12,8	500	80	80	48
Gotoelement Afvoerelement * <i>gezaagd</i>	100	...00100	30,4	1000	100	100	24
		...70100	29,9	1000	100	100	24
		...50100	15,2	500	100	100	48
Gotoelement Afvoerelement * <i>gezaagd</i>	120	...00120	32,1	1000	120	120	24
		...70120	32,6	1000	120	120	24
		...50120	16,1	500	120	120	48



met gietijzeren rooster

* met verticale afvoer DN 100

Inlaat oppervlakte 564 cm²/m, gotoelement met 2 afde kroosters, afdekkingen - gietijzer

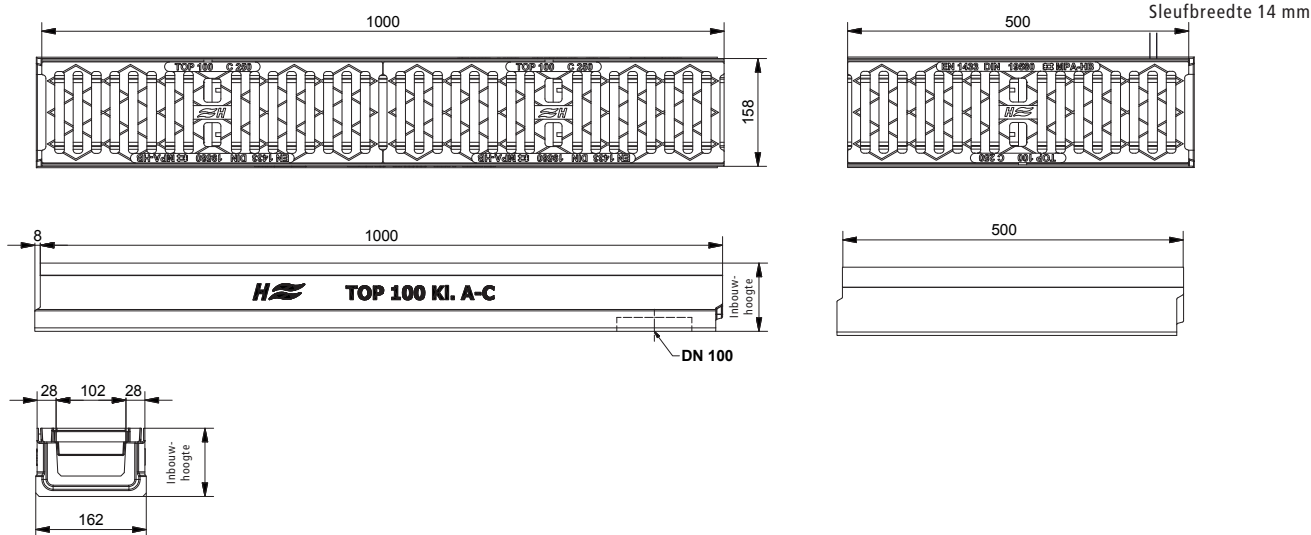

Toebehoren voor TOP 100

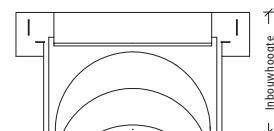

Begin/eindplaat

Art.Nr.:1357001110080 Inbouwhoogte 80
 Art.Nr.:1357001110100 Inbouwhoogte 100
 Art.Nr.:1357001110120 Inbouwhoogte 120